

1. Raise the fuel tank (page 53).
2. Loosen the screw (1), then remove the radiator filler neck (2) from the frame body (3).
3. Remove the radiator mount bolts (4) and collars (5).
4. Move the radiator (6) out of the way and remove the grommet (7) from the radiator stay (8).
5. Pull the radiator toward the front.

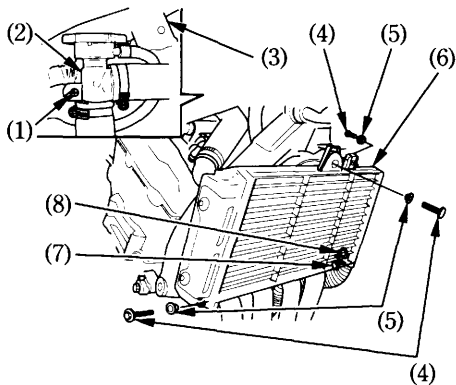

6. Disconnect the spark plug caps from the spark plugs.
7. Clean any dirt from around the spark plug bases. Remove the spark plugs using the spark plug wrench (9) furnished in the tool kit.

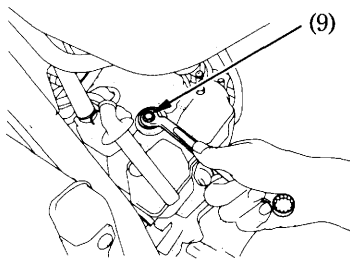

- |                          |                       |
|--------------------------|-----------------------|
| (1) Screw                | (6) Radiator          |
| (2) Radiator filler neck | (7) Grommet           |
| (3) Frame body           | (8) Radiator stay     |
| (4) Radiator mount bolts | (9) Spark plug wrench |
| (5) Collars              |                       |