

Main Fuse:

The main fuse (1) is located under the seat.

The specified fuse is:

30A

1. Remove the seat (page 53).
2. Disconnect the wire connector (2) of the starter magnetic switch.
3. Pull out the old fuse and install a new fuse. The spare main fuse (3) is located behind the starter magnetic switch.
4. Reconnect the connector and install the seat.

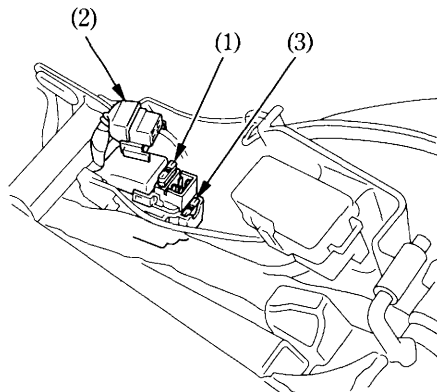

- (1) Main fuse
- (2) Wire connector
- (3) Spare main fuse