

Main fuse, FI fuse:

The main fuse (1) and the FI fuse (2) are located under the front seat.

The specified fuses are:

Main fuse 30A

FI fuse 20A

< CBR1000RR >

1. Remove the front seat (page 81).
2. Release the tabs (3), then remove the starter magnetic switch cover (4).
3. Pull out the old fuse and install a new fuse.
The spare fuses are located in the fuse box (page 142).
4. Install the starter magnetic switch cover and install the front seat.

< CBR1000RR >

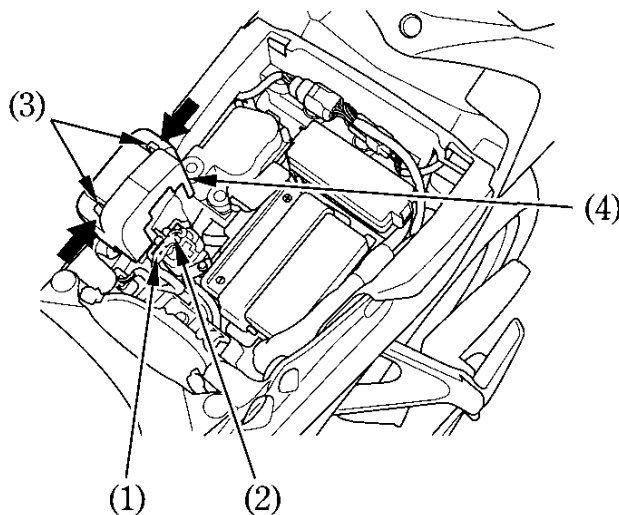

- (1) Main fuse
(2) FI fuse

- (3) Tabs
(4) Starter magnetic
switch cover