

## DRIVE CHAIN SLIDER

Refer to the Safety Precautions on page 84 .

Check the chain slider (1) for wear. The chain slider must be replaced if it is worn to the wear limit line (2). For replacement, see your Honda dealer.

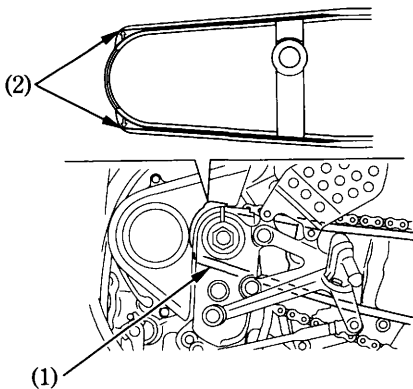

(1) Chain slider

(2) Wear limit line