

DRIVE CHAIN SLIDER

(Refer to the maintenance precautions on page 77).

Check the chain slider (1) for wear.

The chain slider must be replaced if it is worn to bottom of the wear indicator mark (2). For replacement, see your Honda dealer.

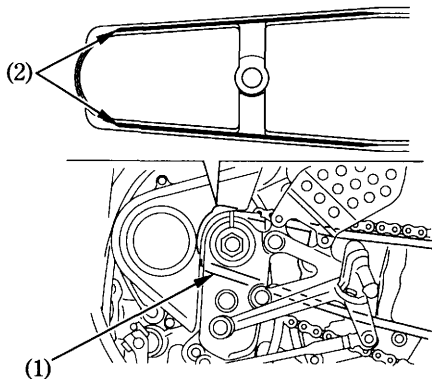

- (1) Chain slider
- (2) Wear indicator mark