

STARTING THE ENGINE

WARNING

- * *Never run the engine in a closed area. The exhaust contains poisonous carbon monoxide gas.*
- * *Do not try to start the engine with the transmission in gear. You may injure yourself or damage the vehicle.*

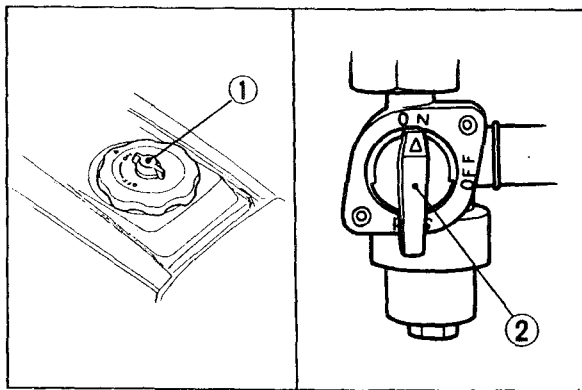

(1) Vent lever

(2) Fuel valve

Preparation

1. Select a level surface and lock the parking brake (page 14) before starting the engine.
2. Turn the fuel cap vent lever (1) and fuel valve (2) to ON.
3. Make sure the engine stop switch (3) is at RUN.

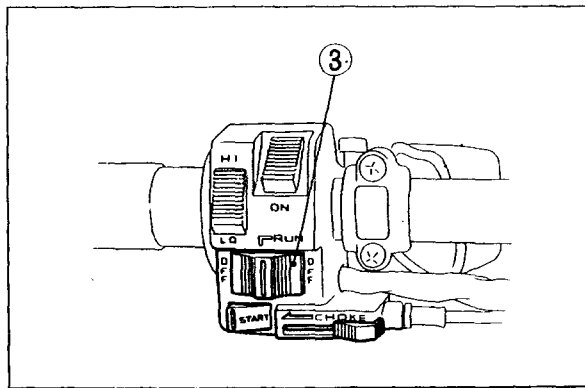

(3) Engine stop switch