

Owner's Manual Storage

Your ATV provides storage for the owner's manual so you'll have it with you for easy reference. Store your owner's manual (1) in the plastic document bag (2) under the seat (2).

The owner's manual and spare fuses (3) should be stored in the plastic document bag (4).

Be careful not to flood this area when washing your ATV.

UNDER THE SEAT

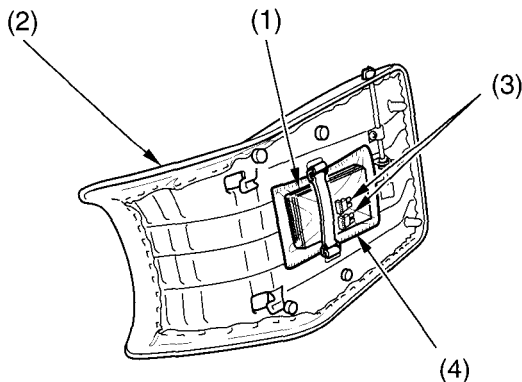

(1) owner's manual
(2) seat

(3) spare fuses
(4) plastic document bag