

Owner's Manual Storage

The owner's manual storage area (Fig. 2-26) is located under the seat (1).

The owner's manual (2) and spare fuse (3) should be stored in the plastic document bag (4).

To remove the seat, see page 128.

Be careful not to flood this area when washing your FOURTRAX or riding through water.

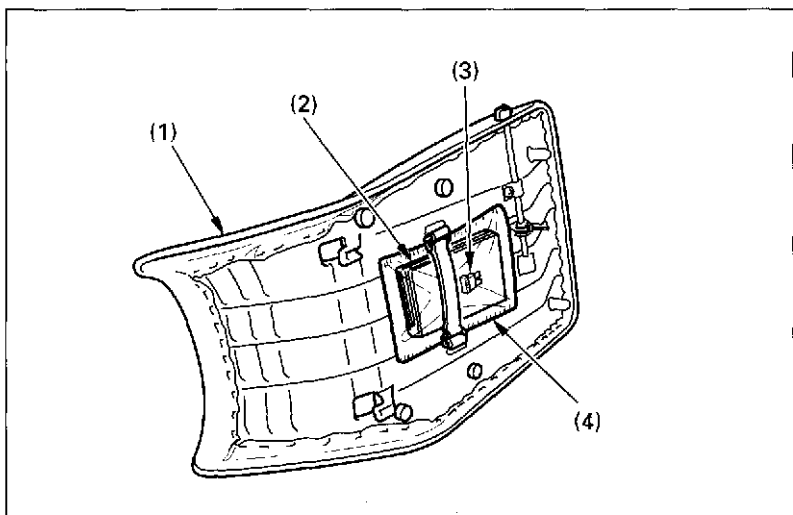

Fig. 2-26

(1) Seat
(2) Owner's manual

(3) Spare fuse
(4) Plastic document bag