

2. Remove the inspection hole plug (Fig.4-21) and measure the lining thickness (2) on both front wheels.

Lining Thickness:

Standard: 4.0 mm (0.16 in)

Service Limit: 2.0 mm (0.08 in)

If either lining is worn beyond the limit, both brake shoes must be replaced by an authorized Honda dealer.

3. If the brake lever free play and the brake shoe lining thicknesses are within the recommended limits, reinstall the inspection hole plugs, seating them into the inspection holes as shown in Fig. 4-21.
4. If the brake lever free play is excessive but the linings are not worn beyond the service limit, adjust the brake lining clearance.

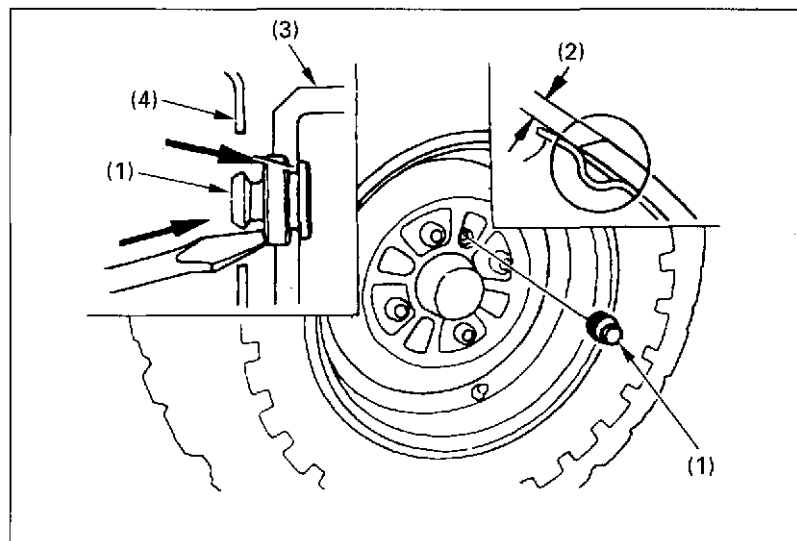

Fig. 4-21 (1) Inspection hole plug (3) Front brake drum
(2) Lining thickness (4) Front wheel rim