

**NOTE:**

Use AWG18-AWG20 electrical wire for attaching an accessory to the special plug. Make sure the accessory leads are properly insulated, and keep them away from hot engine parts and sharp edges.

**CAUTION:**

**Use of an improper wire size may damage the system.**

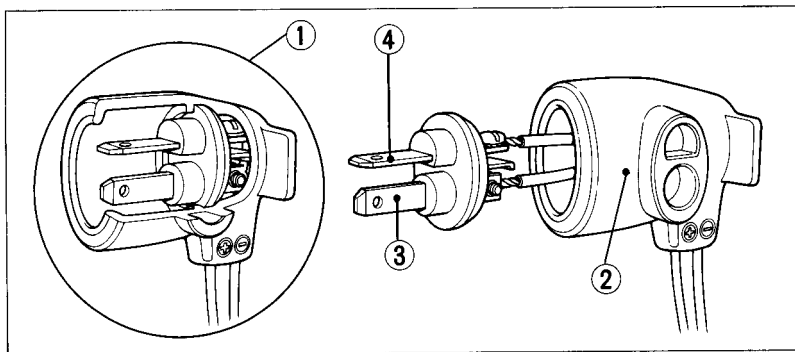

Fig. 2-30

(1) Special DC plug

(2) Plug cover

(3) Positive lead

(4) Negative lead

4. Replace the plug cover.

5. With the ignition switch OFF, insert the plug into the receptacle. Be careful not to twist the accessory leads. Make sure the leads extend from the bottom of the plug.

**CAUTION:**

**To avoid possible damage to electrical components, make sure the ignition switch is OFF when inserting or removing the special DC plug.**

When the receptacle is not being used, cover it with the rubber cap attached to the receptacle to keep out dust, water and sand.