

SKID PLATES

The skid plates (Fig. 4-36) protect the frame/lower arm, the drive components and the rear brake. Check the plates for cracks, damage or looseness at the intervals shown in the Maintenance Schedule.

Have the skid plates replaced if they are cracked or damaged. If the plate bolts are loose, tighten them securely.

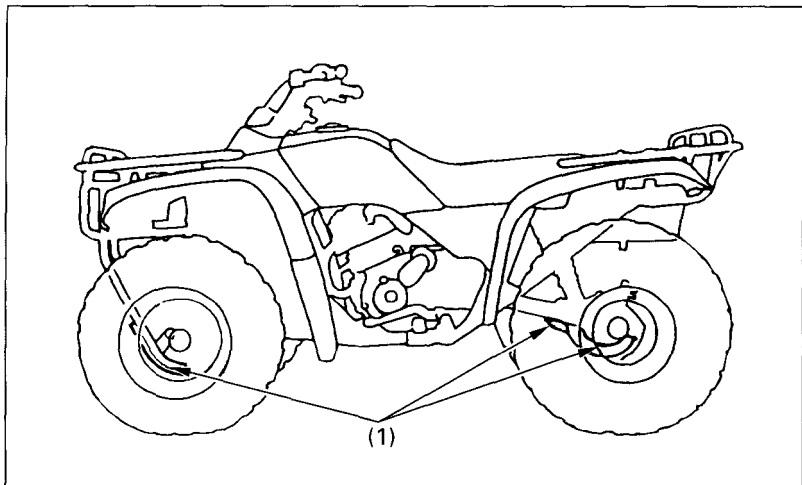

Fig. 4-36

(1) Skid plates