

Spark Plug

4. Inspect the electrodes and center porcelain for deposits, corrosion, or carbon fouling. If the corrosion or deposits are heavy, replace the plug. Clean a carbon or wet-fouled plug with a plug cleaner, if available, or a wire brush. Inspect the spark plug electrodes for wear. The center electrode (2) should have a flat tip and sharp edges, and the side electrode (3) should not be eroded. If the electrodes and insulator tip appear unusually fouled or burned, we suggest that you contact your Honda dealer.
5. Discard the spark plug if there is apparent wear or if the insulator is cracked or chipped.
6. Using a wire-type feeler gauge, check the spark plug gap (4). If adjustment is necessary, bend the side electrode carefully.

The gap should be:

0.03–0.04 in (0.8–0.9 mm)

LEFT SIDE

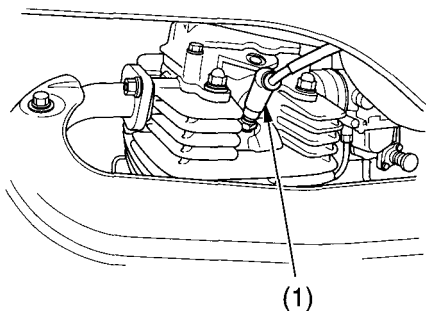

- (1) spark plug cap
(2) center electrode

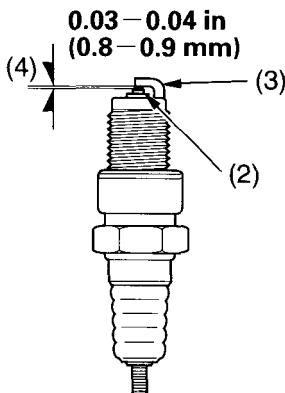

- (3) side electrode
(4) spark plug gap