

Tool Kit

To access the tool kit (5), unhook the rubber band (6) and pull down the tray (7).

The tool kit includes the following items:

- * standard/Phillips screwdriver
- * screwdriver handle
- * 10 × 12 mm open end wrench
- * 14 × 17 mm open end wrench
- * spark plug wrench and handlebar
- * pliers
- * tool case

REAR

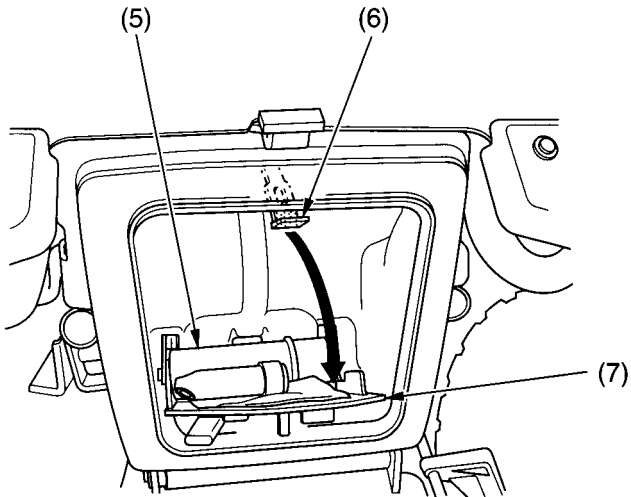

(5) tool kit
(6) rubber band

(7) tray