

FUSE

As illustrated in Fig.4-20 , the fuse box (1) is located in the battery compartment. The main fuse, sub fuses and spare fuses are located in the fuse box.

The specified main fuse is:

30 A

The specified sub fuses are:

15 A × 2, 10 A × 2

If a fuse fails frequently, it usually indicates a short circuit or an overload in the electrical system. See your authorized Honda dealer for repair.

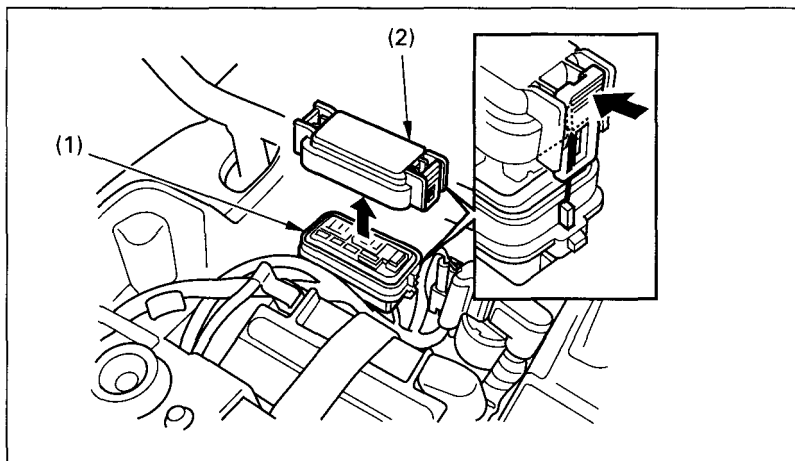

Fig. 4-20

(1) Fuse box
(2) Fuse box cover

To replace the main fuse:

1. Make sure the ignition switch is OFF (○).

CAUTION:

Turn the ignition switch OFF (○) before checking or replacing the fuse to prevent accidental short-circuiting which could damage the electrical system.