

Engine Stop Switch

The engine stop switch (Fig. 2-5) is next to the left handgrip, and it has three positions. When the switch is in the RUN (\circ) position, the engine will operate. When the switch is in either OFF (\otimes) position, the engine will not operate.

This switch is intended primarily as a safety or emergency control, and it should normally remain in the RUN (\circ) position.

NOTE:

If you stop your FOURTRAX by turning the engine stop switch OFF (\otimes), be sure to turn the ignition switch OFF (\circ) to prevent battery discharge.

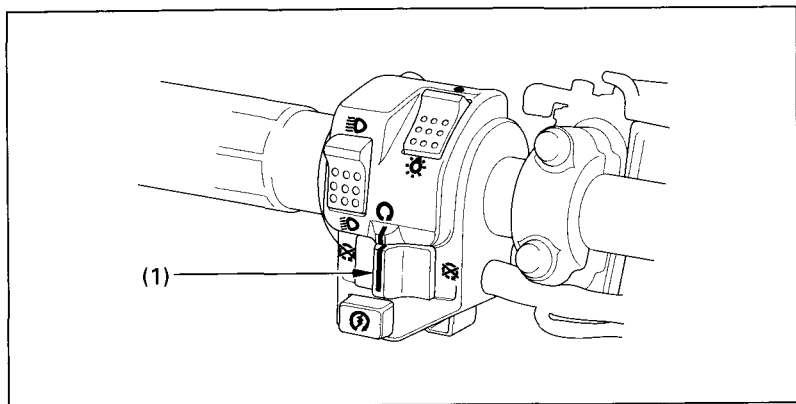

Fig. 2-5

(1) Engine stop switch