

MAINTENANCE AND REPAIRS

EMISSION REQUIREMENTS (USA only)

The California Air Resources Board (CARB) requires that your FOURTRAX comply with applicable exhaust emissions standards during its useful life, when operated and maintained according to the instructions provided.

The Vehicle Emission Control Information Label (1) is attached on the rear fender below the seat.

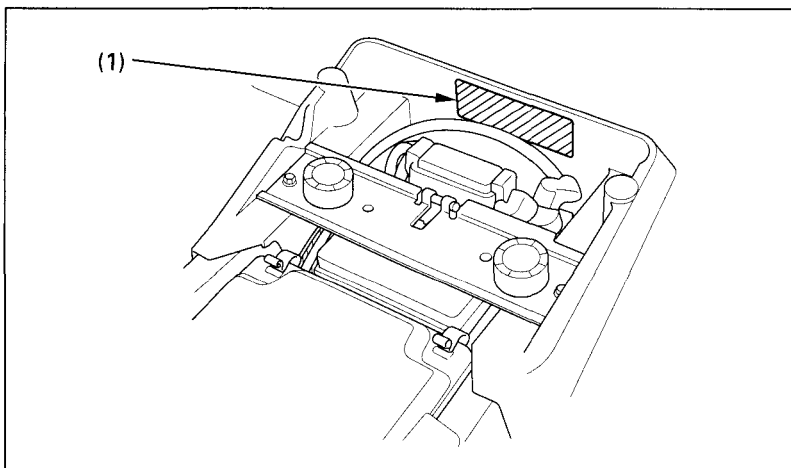

Fig. 3-19

(1) Vehicle Emission Control Information Label