

ADDITIONAL FEATURES

Helmet Holder

The helmet holder (2) (Fig. 2-28) is located on the right side of the handlebar (1). To use the holder, hang the D-ring on your helmet strap over the bracket. Use the helmet holder only when the FOURTRAX is parked.

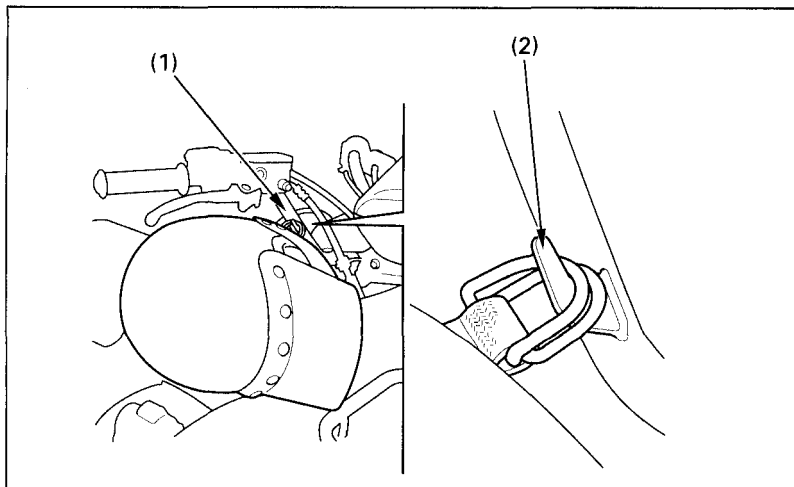

Fig. 2-28 (1) Handlebar

(2) Helmet holder

⚠ WARNING

POTENTIAL HAZARD

Operating this ATV with a helmet attached to the helmet holder.

WHAT CAN HAPPEN

Can impair your ability to steer the vehicle.

HOW TO AVOID THE HAZARD

**Never ride this ATV with a helmet attached to the helmet holder.
Use the helmet holder only while the ATV is parked.**