

## FUEL TANK CONTROLS

### Fuel Gauge

The fuel gauge (Fig. 2-27) (1) shows the approximate fuel supply available. At F (Full), the fuel tank capacity including reserve is:

3.70 US gal (14.0 ℓ , 3.08 Imp gal)

When the gauge needle (2) enters the red band (3), fuel will be low and you should refill the tank as soon as possible. The amount of fuel left in the tank when the needle enters the red band is approximately:

1.00 US gal (3.8 ℓ , 0.84 Imp gal)

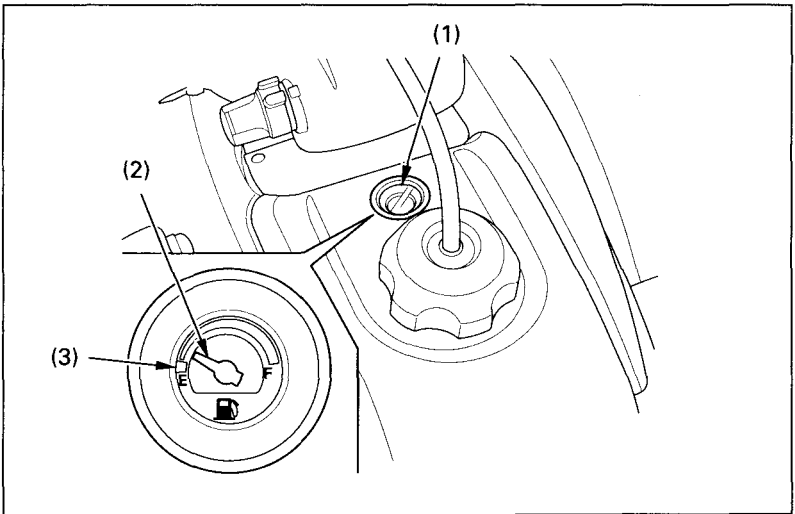

Fig. 2-27 (1) Fuel gauge

(2) Gauge needle

(3) Red band