

REAR BRAKE

This FOURTRAX has a single mechanical drum brake on the rear axle housing. Each day before riding you should check the operation of both the rear brake pedal and the rear brake lever. You should also periodically check the brake shoes for wear.

To check and adjust brake pedal free play:

Measure the distance the rear brake pedal moves before the brake starts to take hold. Free play, measured at the end of the pedal (Fig. 4-30), should be:

9/16 – 13/16 in (15 – 20 mm)

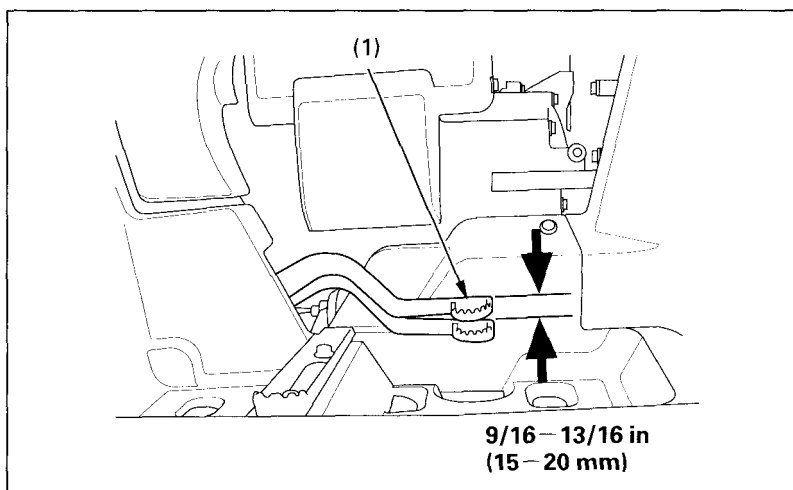

Fig. 4-30

(1) Rear brake pedal