

Shifting Gears

GEAR SHIFTING SEQUENCE

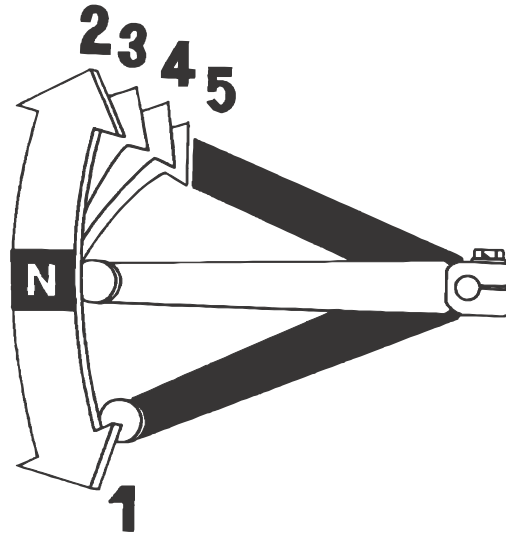

The shift lever is located near the left footpeg. One full stroke of the shift lever shifts the transmission to the next higher or lower gear in the shifting sequence. The shift lever automatically returns to the horizontal position when released.

Your ATV has five forward gears (1, 2, 3, 4 and 5). To shift the transmission, pull in the clutch lever/parking brake lever, then operate the shift lever as follows.

To upshift to a higher gear, put the toe of your boot under the shift lever and raise it one full stroke. To downshift, step on the shift lever and depress it one full stroke.

To select reverse, use the reverse assist lever (page 59).

After starting the engine and letting it warm up, follow these procedures:

1. With the transmission in neutral, depress and hold down the rear brake pedal. Release the clutch lever/parking brake lever (page 27).

(cont'd)