

Seat Removal

Refer to *Safety Precautions* on page 81 .

The seat must be removed for the air cleaner, battery and fuse maintenance, and to access the tool kit and owner's manual.

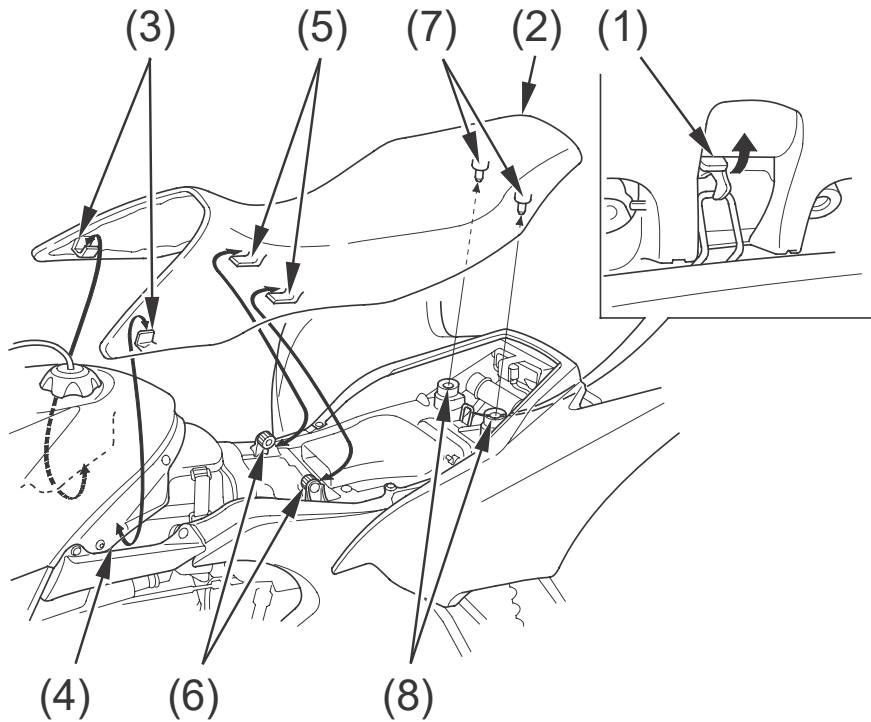

- | | |
|---------------------|--------------|
| (1) seat lock lever | (5) prongs |
| (2) seat | (6) hooks |
| (3) front prongs | (7) studs |
| (4) fuel tank cover | (8) grommets |

Removal

1. Pull the seat lock lever (1) located at the rear end of the seat, directly behind the taillight.
2. Slide the seat (2) back and lift it.

Installation

1. Insert the front prongs (3) into the backside of fuel tank cover (4), prongs (5) into the hooks (6) on the frame, and press the studs (7) into the grommets (8).
2. Press down on the seat until it locks.