

Battery removal:

1. Remove the seat (page 47).
2. Remove the clips (1) and open the battery cover (2).
3. Disconnect the negative (-) terminal lead (3) from the battery first, then disconnect the positive (+) terminal lead (4).
4. Pull out the battery (5) from the battery box.

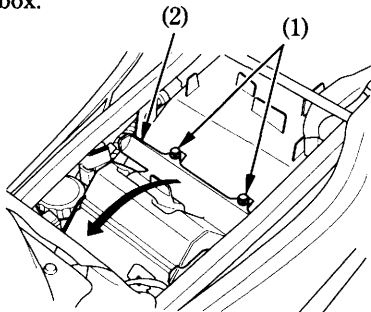

- (1) Clips
(2) Battery cover

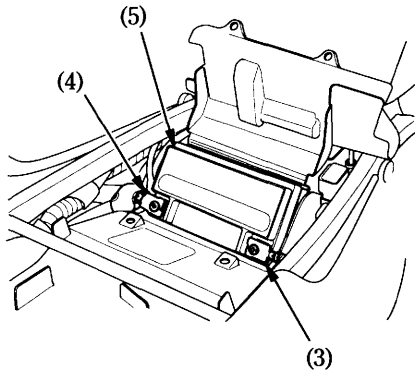

- (3) Negative (-) terminal lead
(4) Positive (+) terminal lead
(5) Battery