

Fuse box:

The fuse box is located behind the right side cover. The specified fuse are:

10A,15A

1. Remove the right side cover (page 35).
2. Open the fuse box cover (1).
3. Pull out the old fuse and install a new fuse.
The spare fuses (2) are located in the fuse box.
4. Close the fuse box cover and install the right side cover.

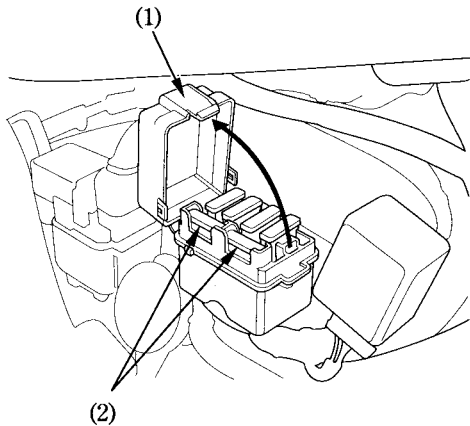

(1) Fuse box cover

(2) Spare fuses