

Main fuse:

The main fuse (1) is located behind the right side cover. The specified fuse is:

30A

1. Remove the right side cover (page 36).
2. Disconnect the wire connector (2) of the stator magnetic switch.
3. Pull out the old fuse and install a new fuse. The spare fuse (3) is located the starter magnetic switch holder.
4. Reconnect the connector and install the right side cover.

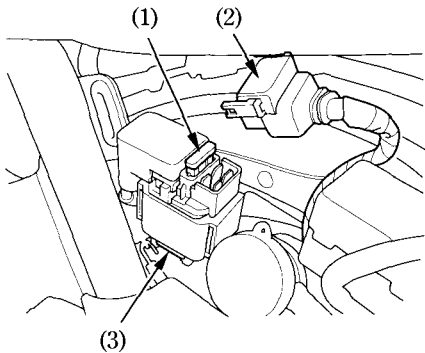

(1) Main fuse
(2) Wire connector

(3) Spare fuse