

Brakes

Fluid Level Inspection

Front Brake Fluid Level Check

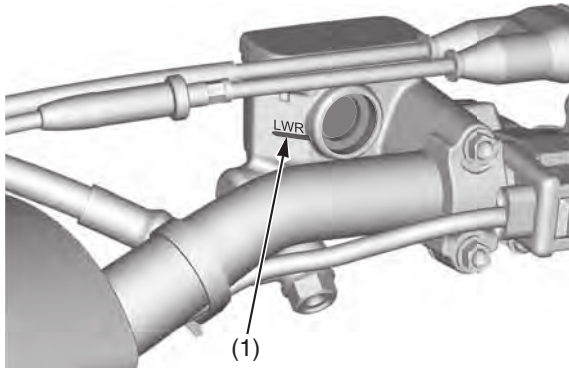

(1) LWR mark

With the motorcycle in an upright position, check the fluid level.

It should be above the LWR mark (1). If the level is at or below the LWR mark, check the brake pads for wear (page 122).

Worn brake pads should be replaced. If the pads are not worn, have your brake system inspected for leaks.

If the pulling distance for the front brake lever feels excessive, there is probably air in the brake system and it must be bled. Refer to an official Honda Service Manual or see your dealer for brake bleeding.

Honda recommends using Honda DOT 4 Brake Fluid from a sealed container, or an equivalent.

Other Checks:

Make sure there are no fluid leaks. Check for deterioration or cracks in the hoses and fittings.

Rear Brake Fluid Level Check

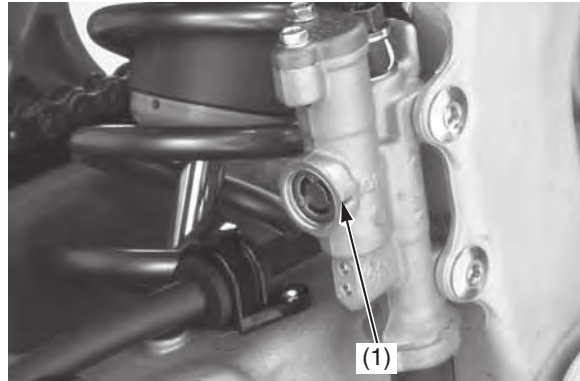

(1) LOWER mark

With the motorcycle in an upright position, check the fluid level.

It should be above the LOWER mark (1). If the level is at or below the LOWER mark, check the brake pads for wear (page 122).

Worn brake pads should be replaced. If the pads are not worn, have your brake system inspected for leaks.

If the travel for the rear brake pedal feels excessive, there is probably air in the brake system and it must be bled. Refer to an official Honda Service Manual or see your dealer for brake bleeding.

Honda recommends using Honda DOT 4 Brake Fluid from a sealed container, or an equivalent.

Other Checks:

Make sure there are no fluid leaks. Check for deterioration or cracks in the hoses and fittings.