

## Maintenance Lid

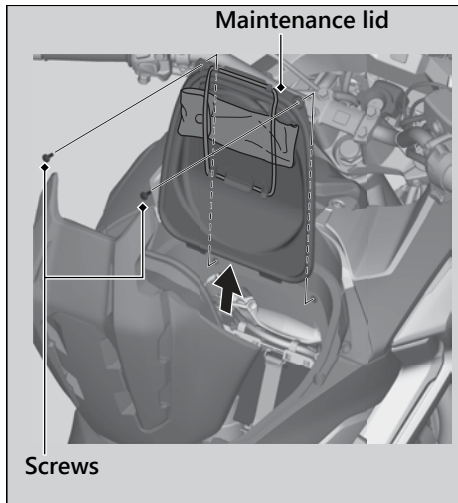

### Removal

1. Open the luggage box. ► P. 70
2. Remove the screws.
3. Remove the maintenance lid.

### Installation

1. Install the maintenance lid.
2. Install and tighten the screws.

**Torque:** 2.2 lbf·ft (3 N·m, 0.3 kgf·m)

3. Close the luggage box.