

# Reverse Inhibitor System

## Reverse Inhibitor System Adjustment

Refer to *Safety Precautions* on page 81.

### LEFT HANDLEBAR

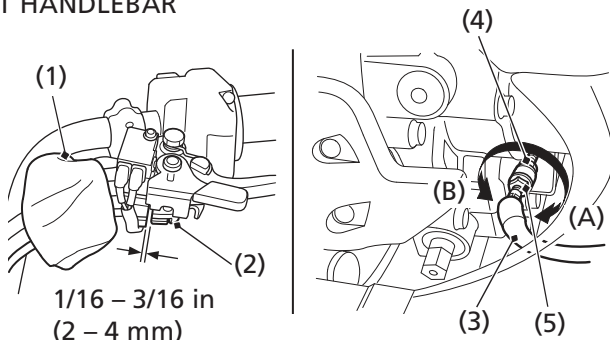

- (1) dust cover
- (2) reverse assist lever
- (3) rubber sleeve
- (4) lock nut

- (5) adjusting nut
- (A) decrease freeplay
- (B) increase freeplay

1. Turn over the dust cover (1).
2. Check the reverse assist lever (2) freeplay, measured at the reverse assist lever end near the cable:  
**1/16 – 3/16 in (2 – 4 mm)**
3. To adjust, slide the rubber sleeve (3), loosen the lock nut (4) and turn the adjusting nut (5) to obtain the correct freeplay.  
After adjustment, tighten the lock nut securely.
4. Return the dust cover and rubber sleeve.

### Other Checks

Check the reverse assist lever and cable for loose connections or other damage. If the cable is worn or kinked, have it replaced by your dealer.