

# Brakes

---

## Brake Shoe Wear

Refer to *Safety Precautions* on page 79.

The rear brake is equipped with an external brake wear indicator that lets you check brake wear without disassembly. Application of the brake control causes the arrow on the brake arm to move toward a reference mark on the brake panel.

### RIGHT REAR

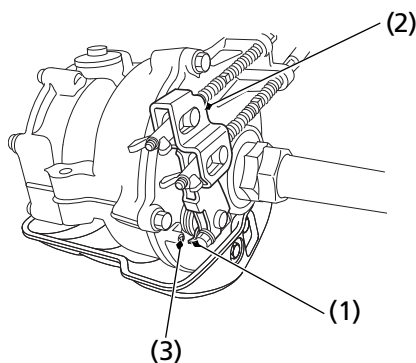

(1) arrow

(3) reference mark

(2) brake arm

1. Apply the brake control and check the movement of the arrow (1) on the brake arm (2).
2. Replace the brake shoe if the arrow aligns with the reference mark (3) on the brake panel upon full application of the brake. If replacement is necessary, see your dealer.