

Controls & Features

Trailer Hitch

REAR

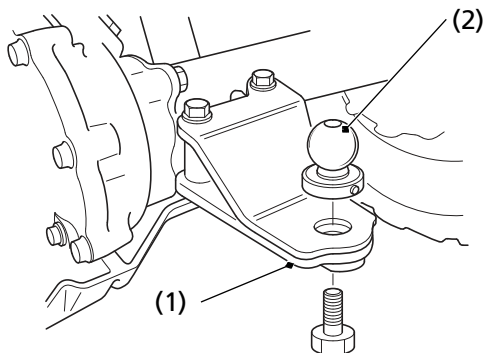

(1) trailer hitch

(2) ball

The trailer hitch (1) is located on the rear axle housing. To use the hitch, you'll need a proper size ball (2) as specified by the trailer manufacturer.

To attach the ball and properly hook up a trailer, follow the trailer manufacturer's instructions. For load limits and operational guidelines, see page 61.