

# Engine Oil & Filter

---

## *Install a New Engine Oil Filter:*

Place shop towels under the oil filter cover because oil will flow out.

1. Remove the oil filter cover (1) and O-ring (2) by removing the bolts (3). Let the remaining oil drain out. Discard the oil filter (4) in an approved manner (page 206).
2. Apply engine oil to a new O-ring and install it to the oil filter cover. Then install a new oil filter. Use only the Honda Genuine oil filter or a filter of equivalent quality specified for your model. Using the wrong Honda filter or a non-Honda filter which is not of equivalent quality may cause engine damage.
3. Install a new oil filter with the rubber seal (5) facing inward, toward the engine. Make sure the spring (6) and the "OUT-SIDE (TOWARDS FILTER COVER)" mark (7) faces away from the engine, toward the oil filter cover.

## NOTICE

*Improper installation of the oil filter can cause serious engine damage.*

### RIGHT SIDE

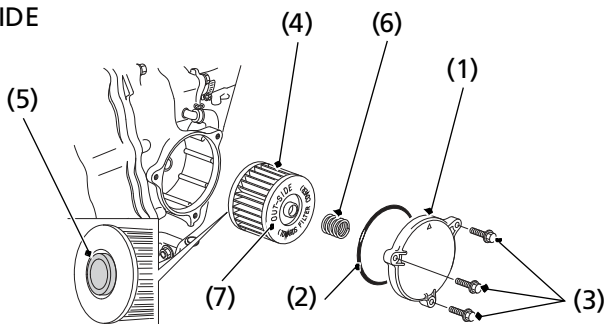

(1) oil filter cover

(2) O-ring

(3) bolts

(4) oil filter

(5) rubber seal

(6) spring

(7) "OUT-SIDE (TOWARDS  
FILTER COVER)" mark