

Front Boot Guards & Front Driveshaft Guards

Refer to *Safety Precautions* on page 111.

FRONT

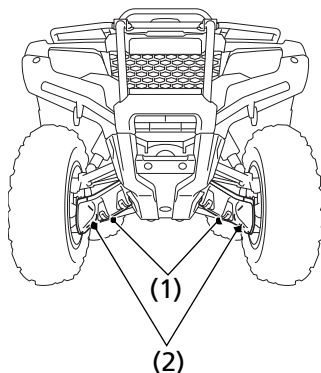

(1) front boot guards (2) front driveshaft guards

Check the front boot guards (1) and front driveshaft guards (2) for cracks, damage or looseness.

Tighten any loose fasteners. Replace the front boot guards and front driveshaft guards as required.