

Guards

Rear Boot Guards

Refer to *Safety Precautions* on page 95.

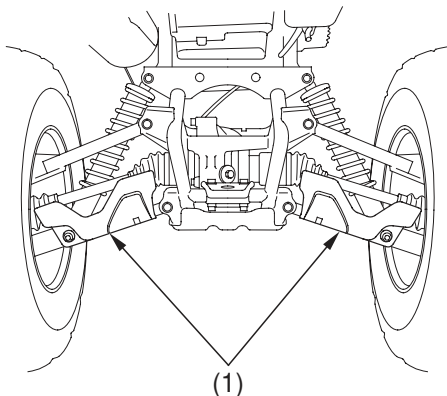

(1) rear boot guards

Check the rear boot guards (1) for cracks, damage or looseness. Tighten any loose fasteners. Replace the rear boot guards as required.