

Seat Removal

Refer to *Safety Precautions* on page 101.

The seat must be removed for the air cleaner, engine oil filter, clutch, spark plug, battery and fuse maintenance and to remove the rear fender cover and tank cover assembly, to access the owner's manual, air pressure gauge, gear change tool, tool kit.

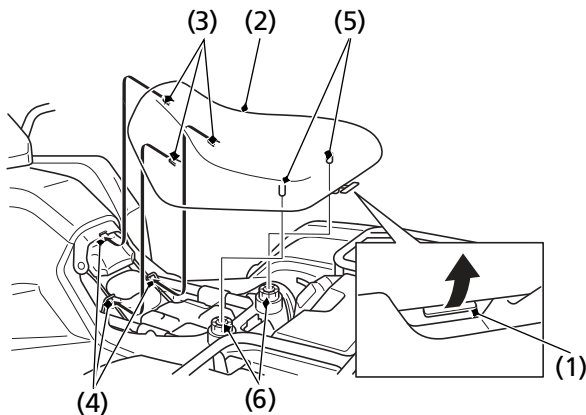

(1) seat latch

(2) seat

(3) front prongs

(4) hooks

(5) studs

(6) grommets

Removal

1. Pull the seat latch (1) at the rear of the seat.
2. Slide the seat (2) back and lift it.

Installation

1. Insert the front prongs (3) into the hooks (4) on the frame and press the studs (5) into the grommets (6).
2. Press down on the seat until locks.