

Rear Final Gear Oil

6. Slowly fill the rear final gear with the recommended oil until oil start to flow out of the oil level check hole (4). Allow oil to settle for 2 – 3 minutes before moving to next step to prevent overfilling.
2.9 US oz (85 cm³)
7. Coat a new O-ring with grease and install it into the fill cap groove and tighten it to the specified torque:
9 lbf·ft (12 N·m , 1.2 kgf·m)
8. Install the oil level check bolt with a new sealing washer and tighten it to the specified torque:
9 lbf·ft (12 N·m , 1.2 kgf·m)
9. Pour the drained oil into a suitable container and dispose of it in an approved manner (page 202).

NOTICE

Improper disposal of drained fluids is harmful to the environment.

REAR

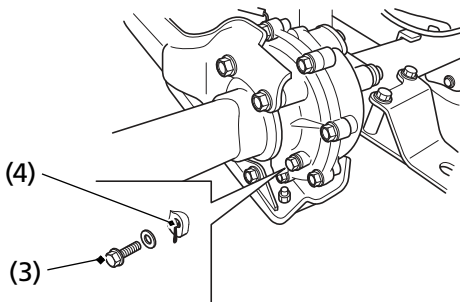

(3) oil level check bolt

(4) oil level check hole