

Brakes

Draining Water from Brakes

Refer to *Safety Precautions* on page 103.

RIGHT REAR

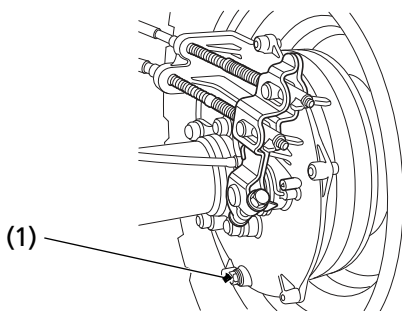

(1) rear brake drain bolt

1. Make sure the engine is OFF and the parking brake is set.
2. Remove the rear brake drain bolt (1) and sealing washer from the bottom of the rear brake panel.
If any water drains, the brake seals must be replaced by your dealer as soon as possible.
3. Install the rear brake drain bolt with a new sealing washer and tighten it to the specified torque:
9 lbf·ft (12 N·m , 1.2 kgf·m)