

Rear Fender Cover Removal

Refer to *Safety Precautions* on page 101.

The rear fender cover must be removed for battery, fuse maintenance and to access the owner's manual, air pressure gauge and tool kit.

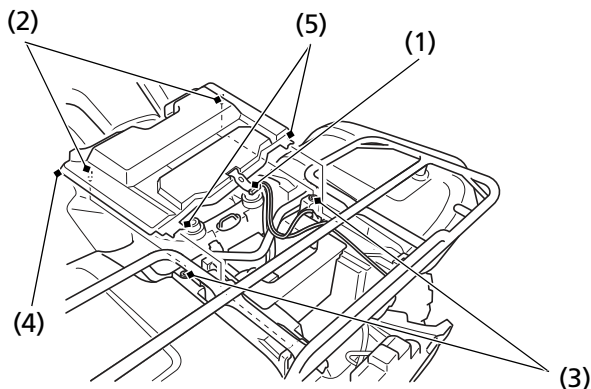

(1) rubber strap

(2) prongs

(3) grommets

(4) rear fender cover

(5) tabs

Removal

1. Remove the seat (page 112).
2. Unhook the rubber strap (1) with opening the storage compartment (page 46).
3. Firmly pull the prongs (2) from their grommets (3).
4. Slide the rear fender cover (4) forward to disengage the tabs (5).
5. Remove the rear fender cover.

Installation

Install the parts in the reverse order of removal.