

Air Cleaner

4. Remove the element holder (3).
5. Loosen the screw (4) and remove the air cleaner assembly (5) from the air cleaner housing.
6. Unscrew the clamp (6).
7. Remove the air cleaner (7) from the air cleaner body (8).
8. Remove the sub air cleaner (9) from the air cleaner joint (10).
9. Gently wash the air cleaner and sub air cleaner in clean, non-flammable (high flash point) solvent such as kerosene—not gasoline.

After cleaning, gently squeeze out the remaining solvent. Avoid twisting or wringing the air cleaner. This can tear the foam.

10. Inspect for tears or cracks in the foam or seams of the air cleaner and/or sub air cleaner. Replace the air cleaner and/or sub air cleaner if it is damaged.

UNDER SEAT

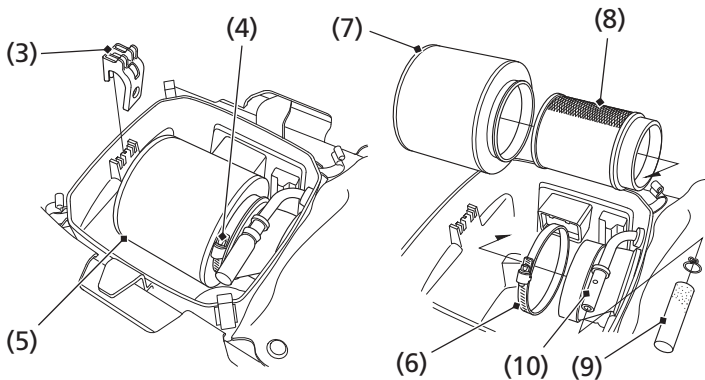

- (3) element holder
- (4) screw
- (5) air cleaner assembly
- (6) clamp

- (7) air cleaner
- (8) air cleaner body
- (9) sub air cleaner
- (10) air cleaner joint

(cont'd)