

# Guards

Refer to *Safety Precautions* on page 111.

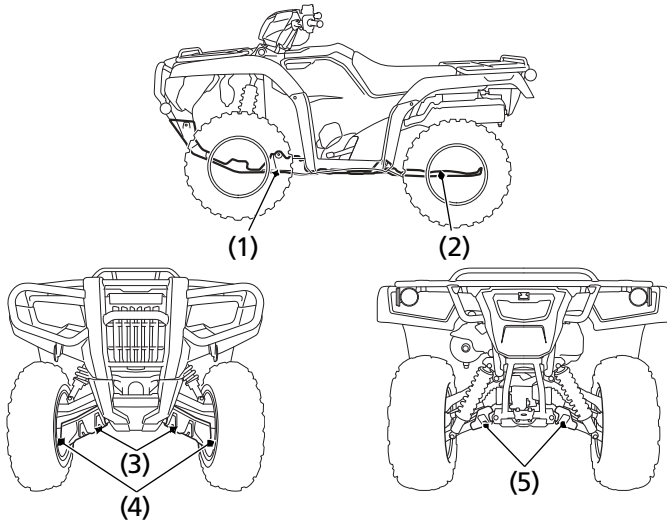

(1) engine guard  
(2) skid plate

(3) front boot guards  
(4) front driveshaft guards  
(5) rear driveshaft guards

The engine guard (1) protects the engine crankcase.

The skid plate (2) protects the frame.

The front boot guards (3) protect the rubber driveshaft boots, and the front driveshaft guards (4) protect the front driveshafts.

The rear driveshaft guards (5) protect the rubber driveshaft boots and the rear driveshafts.

Check the guards and plate for cracks, damage or looseness at intervals shown in the Maintenance Schedule.

Have the guards and skid plate replaced if they are cracked or damaged. If the guard and plate bolts are loose, tighten them securely.