

Fuel

Fuel Capacity

Fuel tank capacity:
4.44 US gal (16.8 ℓ)

The tank should be refilled as soon as possible when the E segment in the fuel gauge flashes.

Refueling Procedure

Refer to *Safety Precautions* on page 129.

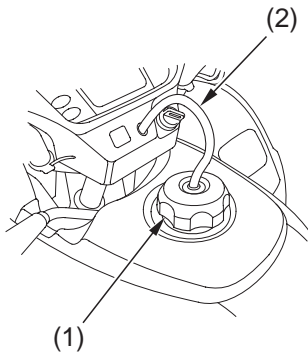

- (1) fuel fill cap
- (2) breather tube

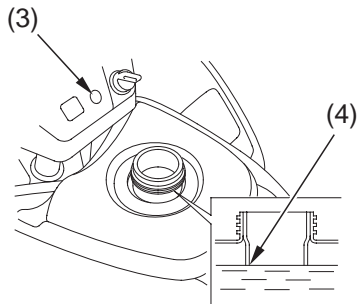

- (3) handlebar cover hole
- (4) filler neck