

Guards

Refer to *Safety Precautions* on page 101.

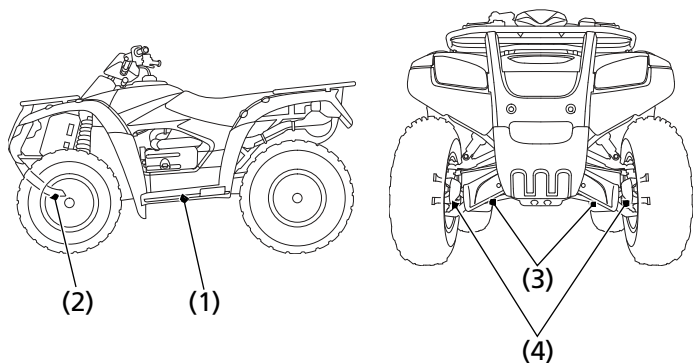

(1) engine guard
(2) skid plate

(3) front boot guards
(4) front driveshaft guards

The engine guard (1) protects the engine crankcase.
The skid plate (2) protects the frame. Check the skid plate and engine guard for cracks, damage or looseness.
Tighten any loose fasteners. Replace the skid plate or engine guard as required.

The front boot guards (3) protect the rubber driveshaft boots, and the front driveshaft guards (4) protect the front driveshaft.

Have the engine guard and skid plate replaced if they are cracked or damaged. If the guard and plate bolts are loose, tighten them securely.