

Engine servicing

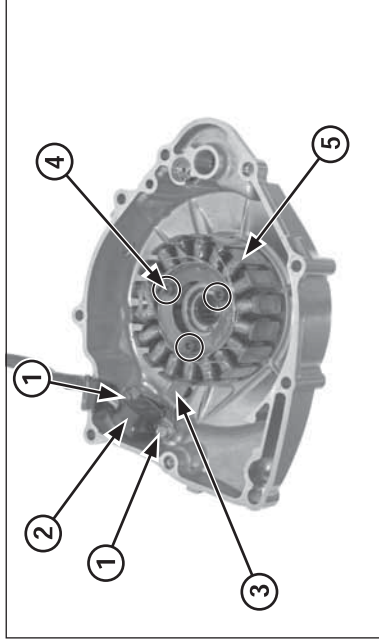

(1) BOLTS (2) IGNITION PULSE GENERATOR
(3) WIRE GUIDE (4) SOCKET BOLTS
(5) STATOR

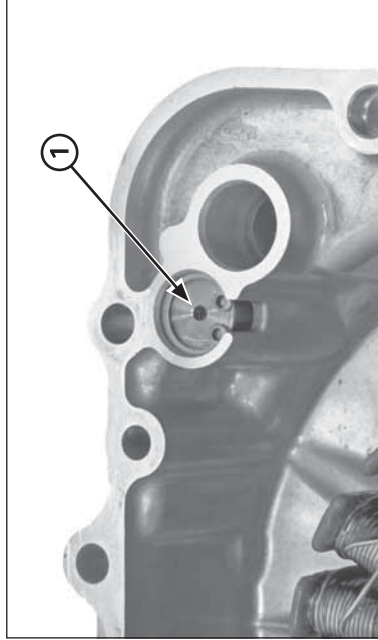

(1) OIL PRESSURE RELIEF VALVE

Disassembly/Assembly

Remove the ignition pulse generator mounting flange bolts and alternator wire clamp.
Remove the stator mounting socket bolts.
Remove the stator/ignition pulse generator from the left crankcase cover.

Remove the oil pressure relief valve (page 3-1).

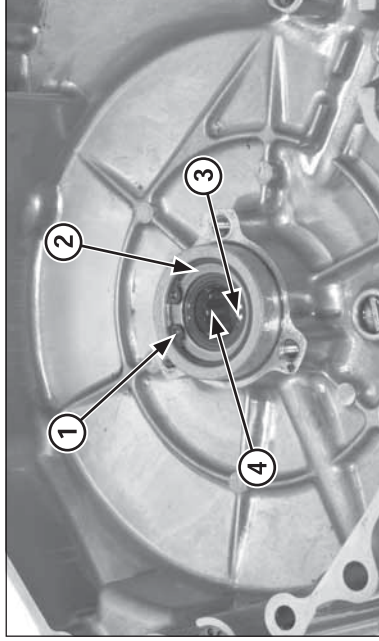

(1) SNAP RING
(2) WASHER
(3) OIL SEAL
(4) NEEDLE BEARING

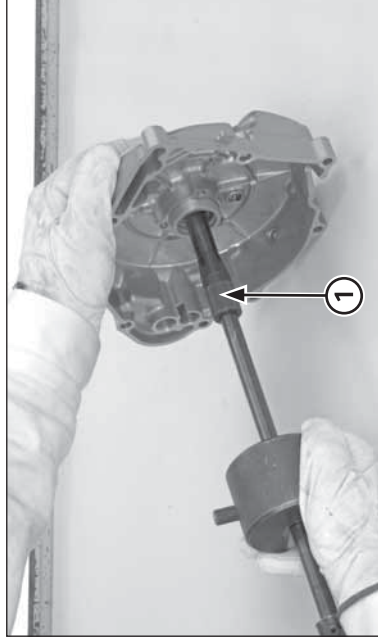

(1) BEARING REMOVER

Check the crankshaft oil seal and needle bearing for wear or damage, replace them if necessary.
Remove the snap ring and washer, then remove the oil seal.

Remove the needle bearing using the special tools.

Tools:

Bearing remover shaft, 15 mm 07936-KC10100
Bearing remover head, 15 mm 07936-KC10200
Remover weight 07741-0010201

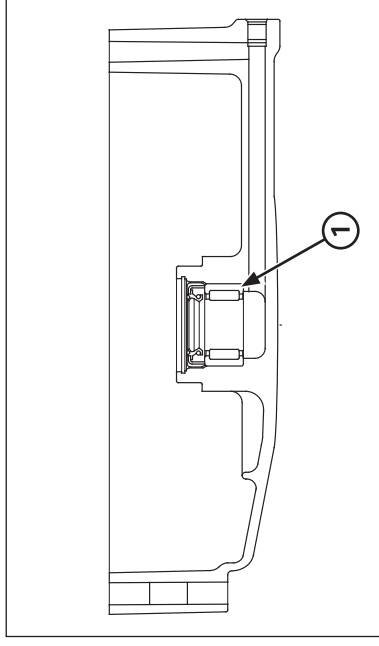

(1) NEEDLE BEARING

Press new needle bearing into the left crankcase cover using the special tools.

Tools:

Driver 07749-0010000
Attachment, 22 x 24 mm 07746-0010800
Pilot, 15 mm 07746-0040300